



Look A-like Keys with GTI Transponder

Edition
FEBRUARY
2014



UK SILCA LOOK A-LIKE KEYS RANGE

GTI is compatible with the new Silca Look A-like transponder keys series: a vehicle keys range with key head design identical to the original.

You will be able to easily recognize Silca Look A-like keys range thanks to the reference ending in TE (eg. F010TE).

- Key head design identical to the original.
- Wide and continuously updated keys range.

IT GAMMA CHIAVI SILCA LOOK A-LIKE

GTI è compatibile con la nuova serie di chiavi elettroniche Silca Look A-like: una gamma di chiavi veicolo con design della testa identica alla chiave originale.

Potrai riconoscere facilmente le chiavi della gamma Silca Look A-like per la referenza terminante in TE (es. F010TE).

- Design testa chiave identica all'originale.
- Gamma di referenze ampia e in continuo aggiornamento.

DE SCHLÜSSEL SILCA LOOK A-LIKE

GTI kann mit den neuen Silca Look A-Like Transponder Schlüsseln verwendet werden: die Fahrzeugschlüssel mit Kopf-Design entsprechend dem Original-Schlüssel.

Die Look-A-Like Schlüssel sind einfach erkennbar dank den Buchstaben "TE" am Ende der Artikelnummer (z.B. F010TE).

- Dem Original entsprechendes Schlüssel-Kopf-Design.
- Reichhaltig Schlüssel-Sortiment mit dauernder Erweiterung.

FR GAMME CLÉS SILCA LOOK A-LIKE

GTI est compatible avec la nouvelle série de clés transpondeurs SILCA Look A-like: une gamme de clés pour véhicule avec un design de la tête identique à la clé originale. Vous pourrez reconnaître facilement les clés de la gamme Silca Look A-like par la référence, qui terminera avec TE (Ex: F010TE).

- Design tête clé identique à l'originale.
- Gamme de références ample et continuellement mise à jour.

ES GAMA LLAVES SILCA LOOK A-LIKE

GTI es compatible con la nueva serie de llaves transponder Silca Look A-like: una gama llaves vehículo con el mismo design de la llave original. Podrá reconocer las llaves de la gama Silca Look A-like a través de la referencia que termina por TE (es. F010TE).

- Design de la cabeza llave idéntico al original
- Gama referencias amplia y en continua evolución.

PT LINHA DE CHAVES SILCA LOOK A-LIKE

O transponder GTI é compatível com a nova linha de chaves Silca Look A-Like: uma linha de chaves para veículos com o formato da cabeça igual às chaves originais. Você será capaz de reconhecer a linha de chaves Look-A-Like graças à referência que acaba sempre em TE (ex.: F010TE).

- Formato da cabeça da chave igual à chave original.
- Ampla linha de chaves sendo atualizada constantemente.

Transponder components / Componenti Transponder / Transponderkomponenten / Composants Transpondeur / Transponder Componentes

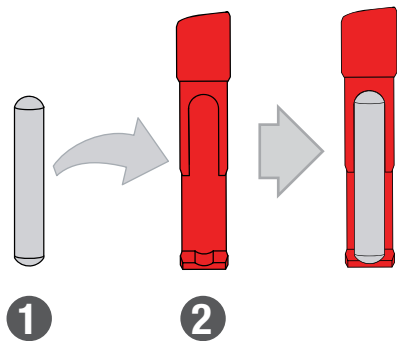

Code / Codice / Código: **C03313**

- | | |
|----------|---|
| 1 | GTI Transponder
Transponder GTI
Transpondeur GTI
Transponder GTI
Transponder GTI |
| 2 | Transponder Adapter
Adattatore transponder
Transponder Adapter
Adaptateur pour transpondeur
Adaptador para transponder
Adaptador para transponder |

Transponder key and GTI / Chiave Transponder e GTI / Transponderschlüssel und GTI / Clé Transpondeur et GTI / Llave Transponder y GTI / Chave Transponder e GTI

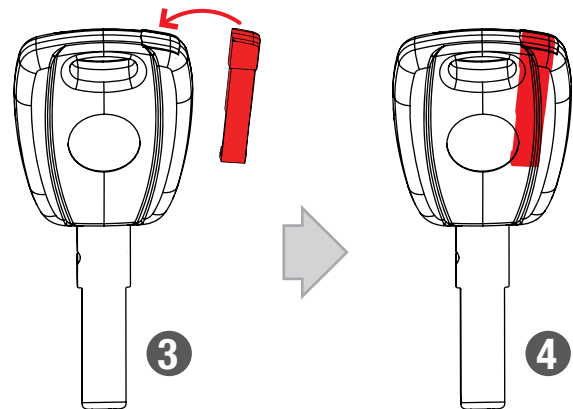

Code / Codice / Código: **SIP22TE**

- | | |
|----------|---|
| 3 | Transponder Key without GTI
Chiave transponder senza GTI
Transponderschlüssel ohne GTI
Clé transpondeur sans GTI
Llave transponder sin GTI
Chave transponder sem GTI |
| 4 | Transponder Key with GTI inside
Chiave transponder con GTI inserito
Transponderschlüssel mit GTI eingefügt
Clé transpondeur avec GTI insérée
Llave transponder con GTI insertado
Chave transponder com GTI inserido |

FO10TE

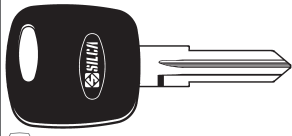

For/Per/Für/Pour/Port/Para:		
FORD SUD-AMERICA		
C-MAX	2004	2007
ECO-SPORT	2003	2007
FIESTA MAX	2005	
FIESTA	2003	

FO21TE



For/Per/Für/Pour/Port/Para:		
FORD AUS		
FALCON	1999	2006
TERRITORY	2004	2005
FORD EU		
CONNECT	2002	
COUGAR	1997	2002
COURIER KOMBI	1998	2002
ESCORT	1995	2000
FIESTA	1995	2002
FIESTA	2003	2008
FOCUS	1998	2004
FUSION	2002	
KA	1996	2002
KA	2002	2008
MONDEO	1995	2001
MONDEO	2001	2007
PUMA	1998	2002
SCORPIO	1995	1998
TRANSIT	1995	2000
TRANSIT	2000	2006
TRANSIT	2007	
TRANSIT	2007	
FORD SUD-AMERICA		
FOCUS	1998	2007
KA	2008	
MONDEO	2006	2007
FORD USA		
TRANSIT CONNECT	2010	2012
JAGUAR		
S-TYPE	2000	2008
XJ	2003	2007
X-TYPE	2002	2008
MAZDA		
121	1997	2001

FO26TE

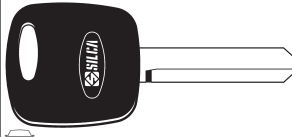

For/Per/Für/Pour/Port/Para:		
FORD USA		
CONTOUR V6 LX	1998	2000
MERCURY		
COUGAR	1999	2002
MYSTIQUE V6 LS	1997	2002

FO38RTE



For/Per/Für/Pour/Port/Para:		
FORD AUS		
ESCAPE	2005	
EXPLORER SPORT TRAC	1998	2001
EXPLORER SPORT TRAC	2002	2005
EXPLORER	1998	2000
EXPLORER	2001	2003
EXPLORER	2004	
FOCUS	2000	2004
TAURUS LX / SHO	1998	1999
TRIBUTE	2001	2003

FO38RTE

FORD SUD-AMERICA		
RANGER	2004	
FORD USA		
HEAVY TRUCKS	2000	2004
FORD USA		
CROWN VICTORIA	1998	2002
CROWN VICTORIA	2003	2012
EDGE	2007	2010
EDGE	2007	2009
ESCAPE	2001	2004
ESCAPE	2005	2012
E-SERIES VAN	2008	
EXCURSION	2000	2006
EXPEDITION	1997	2002
EXPEDITION	2003	2010
EXPLORER SPORT TRAC	1999	2001
EXPLORER SPORT TRAC	2002	2010
EXPLORER	1998	2001
EXPLORER	2001	2003
EXPLORER	2004	2010
F-150	1998	2004
F-150	2004	2010
F-250	1998	2004
F-250	2004	2010
F-350	1999	2003
F-350	2004	2010
FIVE HUNDRED	2005	2007
FLEX	2009	2009
FLEX	2009	2010
FOCUS	2005	2007
FREESTAR	2004	2007
FREESTYLE	2005	2007
FREESTYLE	2005	2007
FUSION	2006	2011
FUSION	2006	2009
MUSTANG COBRA	1996	1997
MUSTANG GT	1996	1997
MUSTANG	1998	2004
MUSTANG	2005	2012
RANGER XLT V6	1999	2000
RANGER	1999	2000
RANGER	2001	2010
TAURUS LX / SHO	1996	1999
TAURUS	2000	2003
TAURUS	2004	2007
TAURUS	2008	2011
TAURUS	2008	2009
THUNDERBIRD	2002	2005
WINDSTAR	1999	2000
WINDSTAR	2001	2003

LINCOLN

LINCOLN		
AVIATOR	2003	2007
BLACKWOOD	2002	2003
CONTINENTAL	1998	2002
CONTINENTAL	2002	2004
LHS	1998	
LS	2000	2006
LS	2003	2006
MARK LT	2005	2009
MKX	2007	2010
MKZ	2006	2011
NAVIGATOR	1997	2002
NAVIGATOR	2002	2008
TOWN CAR	1998	2002
TOWN CAR	2003	
ZEPHYR	2006	

MERCURY

MERCURY		
GRAND MARQUIS	1998	2002
GRAND MARQUIS	2003	2007
MARAUDER	2003	2005
MARINER	2005	2011
MILAN	2006	2011
MONTEGO	2005	2008
MONTEREY	2004	2007
MOUNTAINEER	1998	2001
MOUNTAINEER	2001	2011
SABLE GS, LS	2000	2007
SABLE GS	1999	2000
SABLE LS, SE, SHO	1996	2000

GT10BTE

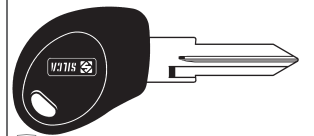

For/Per/Für/Pour/Port/Para:		
CITROËN		
JUMPER	1996	2001
RELAY	1996	2001

GT10BTE

FIAT		
CINQUECENTO	1995	1996
CROMA	1995	1997
DUCATO	1996	2001
FIORINO	1995	2002
PANDA	1995	2002
IVECO		
35C11	2000	
EUROSTAR	1998	2002
NEW DAILY	1998	
S-2000	1998	
PEUGEOT		
BOXER	1996	2001

HON70TE

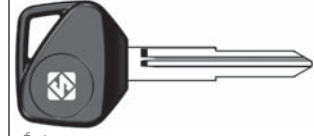

For/Per/Für/Pour/Port/Para:		
HONDA		
BLACK SPIRIT	2010	
CBF600	2007	2012
CBR600F	1999	2006
CBR600RR	2003	
CBR900	2003	
CBR1000	2004	
CBR1100XX	1999	2006
CROSSRUNNER	2011	
CROSSSTOURER	2012	
CTX700	2014	
CTX1300	2014	
HORNET	2003	
INTEGRA	2012	
NC700 S	2012	
NC700 X	2012	
NC750	2014	
NT650V	1999	2006
NT700V	2006	2012
SHADOW 750	2004	
SILVER WING	2001	2008
ST1300 Pan-European	2008	
SW-1400	2009	
SW-T600	2011	
VARADERO	2003	
VFR800	2006	
VFR1200	2009	
VT1300CX	2009	
VT750 C4	2004	2010
VTX1800C	2002	
X-ELEVEN	2001	2003

HU66TE

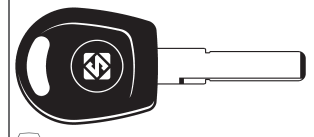

For/Per/Für/Pour/Port/Para:		
AUDI		
A8	2004	
PORSCHE		
CAYMAN	2009	

HU83TE



For/Per/Für/Pour/Port/Para:		
CITROËN		
C4 PICASSO	2006	
C5	2008	
C8	2002	
DISPATCH	2007	
JUMPY	2007	
FIAT		
SCUDO	2007	
ULYSSE	2002	2011
LANCIA		
PHEDRA	2002	2011

HU83TE

PEUGEOT		
207	2006	
208	2012	
307	2001	2009
308	2007	
807	2002	
2008	2013	
3008	2009	
5008	2009	
EXPERT	2007	
RCZ	2010	

HU100TE



For/Per/Für/Pour/Port/Para:		
BUICK		
ALLURE	2010	
LACROSSE	2010	
REGAL	2011	
VERANO	2012	
CADILLAC		
SRX	2010	
CHEVROLET-DAEWOO		
AVEO	2011	
CRUZE	2009	
MALIBU	2012	
ORLANDO	2011	
TRAX	2013	
VOLT	2012	
CHEVROLET SUD-AMERICA		
AGILE	2009	
CHEVROLET USA		
CAMARO	2010	
CRUZE	2011	
EQUINOX	2010	
MALIBU	2013	
ORLANDO	2012	
SONIC	2012	
VOLT	2011	
GMC (GM)		
TERRAIN	2010	
HOLDEN		
ASTRA	2004	
VECTRA	2004	
ZAFIRA	2004	
OPEL-VAUXHALL		
ADAM	2013	
AMPERA	2012	
ASTRA	2004	
CABRIO	2013	
CASCADA	2013	
CORSA	2006	
INSIGNIA	2008	
MERIVA	2010	
MOKKA	2012	
SIGNUM	2003	2008
VECTRA	2004	2008
ZAFIRA	2006	
SATURN (GM)		
ASTRA	2008	2009

HU101TE



For/Per/Für/Pour/Port/Para:		
FORD AUS		
BF FALCON	2005	
TERRITORY	2005	
FORD EU		
FIESTA	2008	2012
FOCUS	2004	2010
FOCUS C-MAX	2003	2010
GALAXY	2006	2010
KUGA	2008	
MONDEO	2007	2010
S-MAX	2006	2010
FORD SUD-AMERICA		
MONDEO	2007	
LAND ROVER		
DISCOVERY 3	2006	2009
RANGE ROVER SPORT	2006	2009

HU133RTE

For/Per/Für/Pour/Para:

FIAT ↳ →

SEDICI 2006

MARUTI SUZUKI ↳ →

ALTO K10 2010
A-STAR 2007
RITZ 2007
SWIFT 2007
SX4 2007
WAGON R 2010
PIXO 2009

PEUGEOT ↳ →

AGILA 2008

SUZUKI ↳ →

ALTO 2009
GRAND VITARA 2008
IGNIS 2003 2008
JIMNY 2002
SPLASH 2008
SWIFT 2005
SX4 2006

HYN6TE

For/Per/Für/Pour/Para:

HYUNDAI ↳ →

ACCENT 1999 2011
COUPE 1996 2001
COUPE 2001 2009
ELANTRA 2000 2006
EXCEL 1999
GALLOPER 1999 2003
GETZ 2002 2009
H-1 1999 2006
H-1 2006
INNOVATION 1999 2003
LANTRA 1996 2000
LAVITA 2001 2010
MATRIX 2002 2010
SANTAFE 2002 2006
SANTAMO 2000 2003
SCOUBE 1996
TERRACAN 2001 2007
TIBURON 2001 2008
TUCSON 2005 2009
VERNA 1999

KIA ↳ →

MORNING 2006
PICANTO 2004 2008
SPORTAGE 2006

HYN10TE

For/Per/Für/Pour/Para:

HYUNDAI ↳ →

ACCENT 1996 1999
ATOS 1997 2000
ATOS PRIME 1999 2001
ATOS PRIME 2002 2008
EXCEL 1996 1999
PONY 1995 1999
VERNA 1996 1999

HYN14TE

For/Per/Für/Pour/Para:

HYUNDAI ↳ →

ENTOURAGE 2007 2009
I10 2008
H-1 BUS 2007

HYN14TE

KIA ↳ →

CARENS 2006
CARNIVAL 2006
OPTIMA 2006
SEDONA 2006

HYN14RTE

For/Per/Für/Pour/Para:

HYUNDAI ↳ →

ELANTRA 2007
GENESIS C.PE 2010
ILOAD 2008
IMAX 2008
SANTAFE 2006
SONATA 2005
VERACRUZ 2007

KIA ↳ →

FORTE (CDN) 2008 2011
MAGENTIS 2006 2008
RONDO 2007 2010
SOUL 2009

MIT8TE

For/Per/Für/Pour/Para:

MITSUBISHI ↳ →

CHALLENGER 1999 2002
CHALLENGER 2002 2003
DIAMANTE 2002 2006
ECLIPSE 1996 2000
ECLIPSE 2001 2005
EXPRESS 1996
FOCUS 1998
GALANT 1996 2000
GALANT 2002 2005
L200 2002 2006
L200 2006
MONTERO 1996 2000
MONTERO 2001 2006
MONTERO 2002 2005
MONTERO 2002 2003
MONTERO SPORT 2000 2002
MONTERO SPORT 2001 2004
MONTERO SPORT 2002 2005
NIMBUS 1998 1999
OUTLANDER 2000 2003
PAJERO SPORT 1999 2002
PAJERO SPORT 2002 2003
PAJERO SPORT 2002 2006
PAJERO 1996 2000
PAJERO 2000 2002
PAJERO 2002 2003
PAJERO 2002 2005
PAJERO 2006
SHOGUN SPORT 1999 2002
SHOGUN SPORT 2002 2003
SHOGUN 1996 2000
SHOGUN 2000 2002
SHOGUN 2002 2003
SHOGUN 2002 2005
SPACE GEAR 1996
SPACE RUNNER 1998 1999
SPACE WAGON 1998 1999
SPACE WAGON 1999 2003
VERADA 2002 2003

MIT11RTE

For/Per/Für/Pour/Para:

CITROËN ↳ →

C-CROSSER 2007
C-ZERO 2011

MIT11RTE

MITSUBISHI ↳ →

380 2006
COLT 1996 2000
ECLIPSE 2008 2012
ENDEAVOR 2007 2011
GALANT (USA) 2008 2012
GALANT 2006
GRANDIS 2003
I-MIEV 2010

MIT11RTE

MITSUBISHI ↳ →

LANCER SW 1996 2003
LANCER 1996 2003
LANCER 2003 2006
LANCER 2006
MIRAGE 1996 2002
MONTERO IO 2000 2006
OUTLANDER 2004 2006
OUTLANDER 2006
PAJERO IO 1999 2004
PAJERO MINI [J] 1999
PAJERO PININ 1999 2004
PAJERO PININ 1999 2004
SHOGUN PININ 1999 2004

PEUGEOT ↳ →

4007 2007
ION 2011

NE72ATE

For/Per/Für/Pour/Para:

NISSAN ↳ →

INTERSTAR 2002 2010
PRIMASTAR 2003

PEUGEOT ↳ →

MOVANO 2002 2010
VIVARO 2002 2010

RENAULT ↳ →

CLIO II 2001 2012
MASTER 2002 2010
THALIA 2001 2008
TRAFIC 2002

RENAULT-DACIA ↳ →

SYMBOL 2010

NE72ATE

For/Per/Für/Pour/Para:

NISSAN ↳ →

INTERSTAR 2002 2010

PEUGEOT ↳ →

106 2000 2004
206 2001 2009
206 Cabrio 2002 2007
206 PLUS 2009

RENAULT ↳ →

AVANTIME 2001 2003
MASTER 2002 2010
MEGANE 1998 2000
MEGANE 2000 2003

NE73TE

For/Per/Für/Pour/Para:

NISSAN ↳ →

INTERSTAR 2002 2010

PEUGEOT ↳ →

106 2000 2004
206 2001 2009
206 Cabrio 2002 2007
206 PLUS 2009

RENAULT ↳ →

AVANTIME 2001 2003
MASTER 2002 2010
MEGANE 1998 2000
MEGANE 2000 2003

NSN11TE

For/Per/Für/Pour/Para:

NISSAN ↳ →

ATLEON 2002
CAB STAR 2000 2003
CAB STAR 2003 2007
MICRA MARCH [J] 2000 2003
MICRA VAN 2000 2003
MICRA 2000 2003
TERRANO II 2002 2006
VANETTE CARGO 2000
VANETTE 2000

NSN11TE

For/Per/Für/Pour/Para:

NISSAN ↳ →

ATLEON 2002
CAB STAR 2000 2003
CAB STAR 2003 2007
MICRA MARCH [J] 2000 2003
MICRA VAN 2000 2003
MICRA 2000 2003
TERRANO II 2002 2006
VANETTE CARGO 2000
VANETTE 2000

NSN14TE

For/Per/Für/Pour/Para:

INFINITI ↳ →

FX35 2003 2009
FX45 2003 2009
G20 2000 2002
G35 2003 2007
I30 2001 2004
I35 2001 2004
M35 2003 2004
M45 2003 2006
Q45 1997 2000
Q45 2001 2005
QX4 1997 1999
QX4 1999 2003
QX56 2004 2007

NSN14TE

NISSAN USA ↳ →

350Z 2003 2009
ALTIMA 2005 2006
ARMADA 2004
CUBE 2009
FRONTIER 2002 2005
FRONTIER 2005 2011
JUKE 2007
LIVINA 2000 2003
MAXIMA 2004 2007
MURANO 2003 2008
NV Series 2012
PATHFINDER 2005 2010
QUEST 2004 2010
ROGUE 2007
SENTRA 2007
TIIDA 2007
TITAN 2004
VERSA 2007
XTERRA 2005 2012
X-TRAIL 2005 2006

NSN14TE

NISSAN ↳ →

ALMERA TINO 2000 2003
ALMERA TINO 2004 2006
ALMERA 2000 2003
ALMERA 2003 2006
JUKE 2010
MICRA 2003
MURANO 2003 2007
NAVARA 2003 2005
NAVARA 2003 2005
NAVARA 2005
NOTE 2006
NP300 2010
PATHFINDER 2005
PATROL 2004
PRIMERA 1998 2000
PRIMERA 2002 2008
PULSAR 1998 2000
QASHQAI 2007
XTERRA 2000 2004
X-TRAIL 2001 2003
X-TRAIL 2004

NSN14TE

SUBARU ↳ →

FORESTER 1998 2003
IMPREZA 1998 2003
LEGACY 1998 2003
OUTBACK 1998 2003

SUZUKI ↳ →

EQUATOR 2009

NSN19TE

For/Per/Für/Pour/Para:

NISSAN ↳ →

CAB STAR 2007

RENAULT ↳ →

MAXITY 2007

SUBARU ↳ →

B9 TRIBECA 2006 2011
BAJA 2005 2007
FORESTER (AUS) 1998 2004
FORESTER 2004 2007
IMPREZA (AUS) 1998 2004
IMPREZA 2004 2007
LIBERTY (AUS) 1998 2003
OUTBACK (AUS) 1998 2003



Look A-like Keys with GTI Transponder

Edition
FEBRUARY
2014

SIP22TE



For/Per/Für/Pour/Por/Para:

ABARTH		
GRANDE PUNTO	2007	2010
PUNTO	2012	
PUNTO EVO	2010	2012
500	2008	
ALFA ROMEO		
GIULIETTA	2010	
MiTo	2008	
156	2001	2003
156 SPORT WAGON	2001	2007
166	2004	2008
CITROËN		
JUMPER	2006	
NEMO	2008	
RELAY	2006	
FIAT		
BRAVO	2007	
DOBLO'	2006	
DUCATO	2006	
FIORINO	2007	
GRANDE PUNTO	2005	
IDEA	2009	
PANDA	2002	
PUNTO	2012	
PUNTO EVO	2009	2012
QUBO	2008	
500	2007	
500L	2012	
FORD EU		
KA	2009	
IVECO		
EUROCARGO	2002	2007
STRALIS	2002	2007
LANCIA		
DELTA	2008	
MUSA	2009	
YPSILON	2011	
PEUGEOT		
BIPPER	2009	
BOXER	2006	

SX9TE



For/Per/Für/Pour/Por/Para:

CITROËN		
BERLINGO	2001	2002
C5	2000	2004
DISPATCH	2002	2006
JUMPY	2002	2006
SAXO	2000	2003
XSARA	2001	2006
XSARA PICASSO	2000	2006
FIAT		
SCUDO	2002	2006
PEUGEOT		
EXPERT	2002	2006
PARTNER	2001	2002
RANCH	2001	2002

SZ11TE

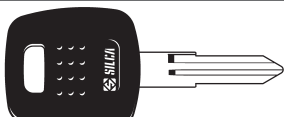

For/Per/Für/Pour/Por/Para:

MARUTI SUZUKI		
ALTO	2007	2010
SUZUKI		
ALTO	2002	2008

SZ11RTE

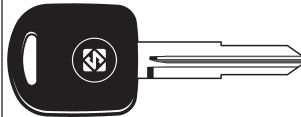

For/Per/Für/Pour/Por/Para:

MARUTI SUZUKI		
VERSA	2007	2010
WAGON R	2007	2010
ZEN ESTILO	2007	2010
SUZUKI		
ALTO	1996	2002
ALTO	2002	2008
BALENO	1996	2001
ESCUDO [J]	1996	2002
GRAND VITARA	1996	2002
GRAND VITARA	2002	2008
IGNIS	2000	2008
JIMNY	1999	2002
JIMNY	2002	
SWIFT	1996	2005
VITARA	1996	2002
VITARA	2002	2008
WAGON R	1998	2000

SZ12TE

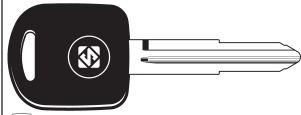

For/Per/Für/Pour/Por/Para:

ISUZU		
BIG HORN	1998	2002
TROOPER	1998	2002
SUBARU		
JUSTY	1996	2003
SUZUKI		
ALTO	1996	2002
BALENO	1996	2001
ESCUDO [J]	1996	2002
GRAND VITARA	1996	2002
SWIFT	1996	2005
VITARA	1996	2002

TOY40BTE



For/Per/Für/Pour/Por/Para:

LEXUS		
CELSIOR [J]	1997	
ES300	1998	2001
LAND CRUISER [J]	1999	
LS400	1997	2000
LX450	1998	
LX470	1999	2000
SC300/400	1998	2003
MITSUBISHI		
MAGNA	1999	2005
VERADA (AUS)	2000	2002
TOYOTA		
LAND CRUISER	1998	2000
CELSIOR	1998	2004
TOYOTA JAPAN		
CELSIOR	1998	2004

TOY41RATE



For/Per/Für/Pour/Por/Para:

TOYOTA JAPAN		
PLATZ	1999	2002
TOYOTA		
ECHO	1999	2005

TOY41RTE

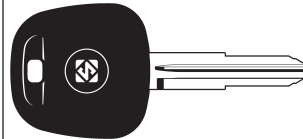

For/Per/Für/Pour/Por/Para:

DAIHATSU		
CHARADE	1998	2004
COPEN	2002	
CUORE	1998	2006
CUORE	2007	
FEROZA	1995	1998
MATERIA	2006	
SIRION	1998	2004
SIRION	2005	
TERIOS	1997	2005
TERIOS	2006	
TREVIS	2007	
YRV	2000	2005
TOYOTA USA		
MR2	2001	2005
TOYOTA		
MR2	1997	2007
YARIS	1999	2005

TOY43ATE

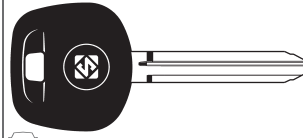

For/Per/Für/Pour/Por/Para:

PONTIAC		
VIBE	2009	2010
SCION		
TC	2005	2010
XA	2004	2007
XB	2004	2008
XD	2008	2012
TOYOTA JAPAN		
ALPHARD	2003	
bb	2000	2005
CALDINA	2002	2004
COROLLA FIELDER	2004	
COROLLA RUNX	2004	
COROLLA SPACIO	2003	
DYNA	2008	
ESTIMA	2001	2003
ESTIMA	2003	
FUN CARGO	2003	2005
GAIA	1999	2004
IPSUM	1996	2003
IPSUM	2003	
ISIS	2003	
TOYOTA JAPAN		
IST	2003	
KLUGER	2001	2003
KLUGER	2003	
LAND CRUISER PRADO	2000	2002
LAND CRUISER PRADO	2002	2005
MARK 2	2000	2006
MARK X	2004	
NOAH	2004	
OPEN DECK	2000	2005
PLATZ	2003	2005
PRONARD	2000	2002
RAUM	2003	
RAV 4	2003	
REGIUSACE	2007	
SIENTA	2003	
TOYOACE	2008	
VANGUARD	2005	
VEROSSA	2001	2004
VITZ	2003	
VOXY	2004	
WISH	2003	
TOYOTA USA		
4RUNNER	1999	2002
4RUNNER	2003	2010
AVALON	1998	2004
AVALON	2005	2011
AVANZA	2004	
CAMRY	1998	2004
CAMRY	2003	2010
COROLLA	2005	2010
FJ CRUISER	2007	2010
HIACE	2006	
HIGHLANDER	2001	2003
HIGHLANDER	2004	2010
LAND CRUISER	1998	2002
LAND CRUISER	2003	2008
MATRIX	2005	2010
PRIUS	2001	2003
PRIUS	2004	2008
RAV 4	2006	2010
SEQUOIA	2001	2002

TOY43ATE

TOYOTA USA		
SEQUOIA	2003	2010
SIENNA	1999	2003
SIENNA	2004	2010
SOLARA	2002	2003
SOLARA	2004	2010
TACOMA	2005	2010
TUNDRA	2005	2010
VENZA	2009	2010
YARIS	2007	2011
TOYOTA		
4RUNNER	1999	2002
ALPHARD	2005	
AURION (AUS)	2006	
AURIS	2006	
AVENSIS VERSO	2001	2003
CAMRY	1996	2005
CAMRY	2006	
CELICA	2000	2005
COROLLA	2007	
ECHO VERSO	2002	2005
TOYOTA		
FJ CRUISER	2007	
FORTUNER	2007	
HIACE	1995	2006
HIACE	2007	
HILUX	1999	2004
HILUX	2005	
INNOVA KIJANG	2005	
iQ	2008	
LAND CRUISER 90	1996	2002
LAND CRUISER 100	1998	2002
LAND CRUISER 100	2003	
LAND CRUISER 120	2002	
LAND CRUISER PRADO	2002	
PICNIC	1996	2003
PICNIC	2003	2008
PREVIA	2000	2003
PREVIA	2003	2008
PRIUS	2000	2003
RAV 4	2005	2010
REIZ	2005	
T.U.V.	2003	
TARAGO	2003	2008
VIOS	2007	
WISH	2004	

TOY43TE

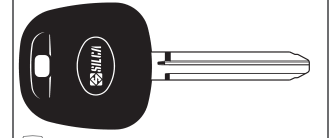

For/Per/Für/Pour/Por/Para:

TOYOTA		
COROLLA	1996	2006
RAV 4	1996	2004

TOY46RTE



For/Per/Für/Pour/Por/Para:

TOYOTA		
COROLLA	1996	1999

TOY47TE



For/Per/Für/Pour/Por/Para:

DAIHATSU		
CHARADE	2011	
TOYOTA		
AURIS (EU)	2007	
AVENSIS	1998	2000
AVENSIS	2000	2003
AVENSIS	2003	
CARINA	1996	2000
COROLLA (S.Africa)	2008	
COROLLA	1999	2006
YARIS	1999	2005
YARIS	2005	2011



Look A-like Keys with GTI Transponder

Edition
FEBRUARY
2014

VA2TE



For/Per/Für/Pour/Por/Para:

SMART	→	→
FORTWO	2009	

VAC102TE

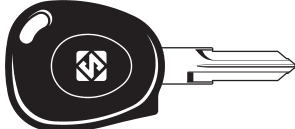

For/Per/Für/Pour/Por/Para:

RENAULT	→	→
KANGOO	2002	2010
TWINGO	2002	2007
RENAULT-DACIA	→	→
DUSTER	2010	
LOGAN	2006	
SANDERO	2008	

YH35RATE



For/Per/Für/Pour/Por/Para:

YAMAHA	→	→
BT1100 Bulldog	2005	
FJR1300	2005	
FZ1	2006	
FZ6	2004	2011
FZ8	2010	
FZS1000 FAZER	2005	
Majesty 400	2005	
MT-01	2005	2012
MT-03	2006	
TDM600	2005	
T-MAX 500	2005	2012
XJR 1300	2004	
XT660Z Ténéré	2008	
XT1200Z Super Ténéré	2010	
XTR	2004	
XTX	2004	
XVS650A DragStar	2004	2006
XVS1100A DragStar	2004	
YZF-R1	2005	
YZF-R6	2003	

ZD24RTE

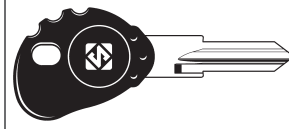

For/Per/Für/Pour/Por/Para:

HONDA	→	→
SH300	2007	
TRIUMPH	→	→
TIGER	2010	
YAMAHA	→	→
X-MAX 125	2006	

→ In production from year... / Fabricata dall'anno... / Hergestellt seit Jahr... / Fabriqué à partir de l'année... / Fabricada desde el año... / Em produção do ano...

→ In production until year... / Fabricata fino all'anno... / Hergestellt bis Jahr... / Fabriqué jusqu'à l'année... / Fabricada hasta el año... / Em produção até ano...

EN **IMPORTANT** - In compliance with current regulations relating to industrial property, we hereby state that the trade-marks or trade names mentioned in our catalogue are the exclusive property of authorized manufacturers of locks and users. Said trade-marks or trade names are nominated only for the purposes of information so that any lock for which our keys are made can be rapidly identified. This catalogue is reserved exclusively for professional key cutters who use Silca products. All information and illustrations in this catalogue are for guidance only. Silca reserves the right to alter products designs, dimensions or info to improve the products quality. The contents of this catalogue are fully protected by Copyright and may not be copied or reproduced in any form, without written permission from Silca. Any infringements will be dealt with under Italian law.

IT **IMPORTANTE** - In conformità alle disposizioni legali in vigore relative alle proprietà industriali, informiamo che i marchi o le denominazioni commerciali citate nel nostro catalogo sono di proprietà esclusiva dei fabbricanti di serrature e degli utilizzatori autorizzati. Questi marchi o denominazioni commerciali sono indicati a titolo di semplice informazione, con lo scopo di riconoscere velocemente a quali serrature le nostre chiavi sono destinate. Questo catalogo è esclusivamente riservato ai professionisti della riproduzione chiavi che utilizzano i prodotti Silca. Le illustrazioni e i dati tecnici dei prodotti contenuti nel catalogo debbono considerarsi indicativi. Silca si riserva il diritto, ferme restando le caratteristiche essenziali dei prodotti, di apportare tutte le modifiche che ritiene necessarie e opportune al fine di migliorare la qualità dei prodotti. Tutti i disegni e le fotografie sono di proprietà di Silca, ogni riproduzione anche parziale, senza autorizzazione scritta della Silca è vietata secondo termini di legge. Per qualsiasi controversia competenti sono gli Uffici Giudiziari dove ha sede l'Azienda, con esplicita esclusione di qualsiasi altro foro.

DE **WICHTIG** - Gemäß den derzeit geltenden Normen bezüglich des Industrieigentums teilen wir Ihnen mit, daß die im vorliegenden Katalog angeführten Markennamen oder Handelsmarken ausschließliches Eigentum der Schloßhersteller und zugelassenen Fachhändler sind. Diese Markenbezeichnungen oder Handelsmarken sind nur zur Information angeführt, mit dem Zweck, schnell erkennen zu können, zu welchem Schloß unsere Schlüssel gehören. Der vorliegende Katalog ist ausschließlich an Schlüsselkopier-Fachgeschäfte, die Silca Produkte benutzen, gerichtet. Die Abbildungen und technischen Daten des Katalogs sind nur zur Information. Silca behält sich vor, etwaige Änderungen am Produkt, die zur Verbesserung desselben beitragen vorzunehmen. Alle Zeichnungen und Fotos sind Besitz der Firma Silca, jede Reproduktion, auch teilweise, ist ohne schriftliche Erlaubnis der Firma Silca gesetzlich untersagt. Im Falle von Streitfragen ist der Gerichtshof des Firmensitzes zuständig; jeder andere Gerichtshof ist ausgeschlossen.

FR **IMPORTANT** - Conformément aux lois en vigueur concernant la propriété industrielle, nous vous informons que les marques et appellations commerciales citées dans notre catalogue appartiennent exclusivement aux fabricants de serrures et aux utilisateurs autorisés. Ces marques ou appellations commerciales sont indiquées à titre d'information pure et simple pour vous permettre de déterminer rapidement les serrures auxquelles nos clés sont destinées. Ce catalogue est réservé exclusivement aux professionnels du taillage de clés qui utilisent les produits Silca. Les illustrations et les caractéristiques techniques des produits présentés dans ce catalogue sont données à titre indicatif. Bien que les caractéristiques essentielles des produits soient invariables, Silca se réserve le droit d'apporter toutes les modifications qu'elle retiendra nécessaires et opportunes afin d'améliorer la qualité de ses produits. Tous les dessins et photos sont propriété Silca et toute reproduction, même partielle, sans l'autorisation écrite préalable de Silca est interdite conformément aux prescriptions légales. Tout litige est du ressort exclusif des Tribunaux de la circonscription où se trouve le Siège de la Société.

ES **IMPORTANTE** - En conformidad con las disposiciones legales vigentes sobre la Propiedad Industrial, las marcas y denominaciones comerciales citadas en nuestra documentación se declaran propiedad exclusiva de los fabricantes de cerraduras y los usuarios autorizados. Dichas marcas o denominaciones comerciales se citan con mero carácter informativo, con objeto de hacer comprender sin dificultad a qué cerraduras van destinadas nuestras llaves. Esta documentación está reservada exclusivamente a los profesionales de la duplicación de llaves que utilizan los productos Silca. Las ilustraciones y los datos técnicos de los productos en esta documentación son indicativos. Silca se reserva el derecho, quedando invariables las características principales de los productos, de modificar todo lo que considere necesario y oportuno para mejorar la calidad de sus artículos. Todos los dibujos y fotografías pertenecen a Silca; según determina la Ley, se prohíbe toda reproducción, total o parcial, sin autorización por escrito de Silca S.p.A. En caso de disconformidad, la competencia es de las autoridades judiciales donde esté domiciliada la firma, excluyendo cualquier otro Tribunal.

PT **IMPORTANTE** - Em conformidade com as disposições legais em vigor relativas à propriedade industrial, informamos que as marcas ou as denominações comerciais citadas no nosso catálogo são propriedade exclusiva dos fabricantes de fechaduras e dos utilizadores autorizados. Estas marcas ou denominações comerciais são indicadas só a nível de informação, a fim de reconhecer rapidamente a quais fechaduras se destinam as nossas chaves. Este catálogo é reservado exclusivamente aos profissionais da reprodução de chaves que utilizam os produtos Silca. As ilustrações e as características técnicas dos produtos apresentados neste catálogo são facultados a título indicativo. Mesmo que as características essenciais dos produtos sejam invariáveis, à Silca reserva-se o direito de modificar ser necessário e oportuno os produtos, a fim de melhorar a sua qualidade. Todos os desenhos e fotos são propriedade da Silca, e é proibida a sua reprodução mesmo parcial sem a autorização escrita da Silca conforme as prescrições legais. Em caso de litígio fica desde já designado, excluindo qualquer outro, o Tribunal da comarca onde está registada a sede da Silca.