



# MH-TA Electronic Keys with GTI Transponder

Edition  
FEBRUARY  
2014



## 🇬🇧 MH-TA ELECTRONIC KEYS

GTI, the first programmable and multifunctional glass transponder worldwide, can now be applied also to the electronic Silca MH keys range with TA adapter (MH-TA).

Discover all the vehicle models for which the MH-TA with GTI Solution is available.

## 🇮🇹 CHIAVI ELETTRONICHE MH-TA

GTI, il primo transponder in vetro al mondo programmabile e multifunzionale, da oggi può essere applicato anche alla gamma chiavi elettroniche Silca MH dotate di adattatore TA (MH-TA).

Scopri tutti i modelli veicolo per cui è disponibile la Soluzione MH-TA con GTI.

## 🇩🇪 ELEKTRONISCHE SCHLÜSSEL MH-TA

GTI, der erste multifunktionale Universal-Glas-Transponder weltweit, kann ab heute auch mit dem Silca elektronischen MH Kopf in Verbindung mit dem TA Adapter (MH-TA) verwendet werden.

Entdecken Sie die komplette Liste der Automodellen, für die die MH-TA Lösung verfügbar ist.

## 🇫🇷 CLES ÉLECTRONIQUES MH-TA

GTI, le premier transpondeur en verre au monde, programmable et multifonctionnel, qui peut-être dès aujourd'hui utilisé également pour la gamme de clés électroniques Silca MH dotées d'adaptateur TA (MH-TA).

Découvrez tous les modèles de véhicule pour lesquels est disponible la Solution MH-TA avec GTI.

## 🇪🇸 LLAVES ELECTRÓNICAS MH-TA

GTI, el primer transponder de cristal programable y multifunción, ahora se puede usar con la gama llaves electrónicas Silca MH usando o adaptador TA (MH-TA).

Descubra todos los modelos vehículo que pueden utilizar la Solución MH-TA con GTI.

## 🇵🇹 CHAVES ELETRÔNICAS MH-TA

GTI, o primeiro transponder de vidro programável e multifuncional do mundo, pode ser agora colocado nas chaves eletrônicas Silca MH usando o adaptador TA (MH-TA).

Descubra os modelos de veículos para os quais o adaptador MH-TA com o transponder GTI.

## MH-TA

Key components and codes / Componenti chiave e codici / Schlüsselkomponenten und Codes / Composants clés et codes / Componentes llave y códigos / Componentes chave e códigos

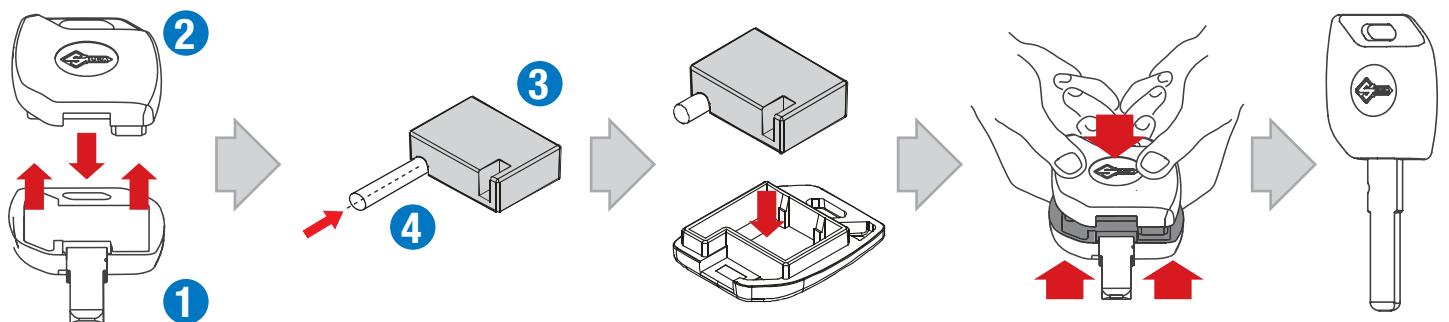

Code / Codice / Código: HU66MH

Code / Codice / Código: MH-TA

Code / Codice / Código: C03313

**1** Blade with empty head  
Gambo con testa vuota  
Schaft mit leerer Kopf  
Tige avec tête vide  
Paletilla con cabeza vacía  
Haste com cabeça vazia

**2** Empty head with transponder adapter  
Testa vuota con adattatore transponder  
Leerer Kopf mit Transponder Adapter  
Tête vide avec adaptateur pour transpondeur  
Cabeza vacía con adaptador para transponder  
Cabeça vazia com adaptador para transponder

**3** Transponder Adapter  
Adattatore transponder  
Transponder Adapter  
Adaptateur pour transpondeur  
Adaptador para transponder  
Adaptador para transponder

**4** GTI Transponder  
Transponder GTI  
Transpondeur GTI  
Transponder GTI  
Transponder GTI



# MH-TA Electronic Keys with GTI Transponder

Edition  
**FEBRUARY**  
2014

BW9MH			
For/Per/Für/Pour/Para:			
BMW			
C600 SPORT	2012		
C650 GT	2012		
F650	2008	2011	
G650	2011		
F800	2006		
K1200	2005	2008	
K1300	2009		
K1600	2011		
R1200	2005		

CY24MH			
For/Per/Für/Pour/Para:			
CHRYSLER			
200	2011		
300	1998	2004	
300	2005	2008	
ASPEN	2007	2009	
CIRRUS	1999	2000	
CIRRUS Convertible	2001		
CIRRUS SEDAN	2001		
CONCORDE	1998	2004	
LHS	1999	2001	
NEON	2000	2005	
NEW YORKER	1998	2001	
PACIFICA	2004	2008	
PT CRUISER	2001	2005	
PT CRUISER	2006	2011	
PT CRUISER LE	2001	2005	
SEBRING	2007	2011	
SEBRING CONVERT	2001	2006	
SEBRING CONVERT	2007	2011	
SEBRING SEDAN	1999	2006	
STRATUS	1998	2006	
TOWN & COUNTRY	2001	2004	
TOWN & COUNTRY	2004	2007	
VISION	1998		
VOYAGER	1998	2003	
VOYAGER	2004	2007	

DODGE			
AVENGER	2008		
CALIBER	2007	2013	
CARAVAN	2001	2003	
CARAVAN	2004	2007	
CHARGER	2005	2008	
DAKOTA	2001	2004	
DAKOTA	2005	2012	
DURANGO	2001	2004	
DURANGO	2005	2008	
INTREPID	1998	2004	
INTREPID SEDAN, ES	2001	2004	
MAGNUM	2005	2007	
NEON	2000	2005	
NITRO	2007	2012	
RAM	2002	2005	
RAM	2006	2010	
STRATUS SEDAN	1998	2006	

EAGLE			
VISION	1998		

JEEP			
CHEROKEE	1998	2004	
CHEROKEE	2005		
CHEROKEE LIMITED	1999	2005	
CJ5,CJ7	1998	2005	

CY24MH			
JEEP			
CJ5,CJ7	2006		
COMANCHE	2006		
COMMANDER	2006	2008	
COMPASS	2007		
G. CHEROKEE	2005	2008	
G. CHEROKEE LUX	1999	2005	
G. CHEROKEE SPORT	1998	2004	
LIBERTY	2002	2004	
LIBERTY	2005		
PATRIOT	2007		
WRANGLER	1998	2006	
WRANGLER	2006		
MITSUBISHI			
RAIDER	2006	2010	
PLYMOUTH			
BREEZE	1999	2001	
NEON	2000	2001	
PROWLER	2000	2002	
STERLING			
BULLET	2008		

DAT17MH			
For/Per/Für/Pour/Para:			
SUBARU			
B9 TRIBeca	2007		
FORESTER	2008		
IMPREZA	2007		
LEGACY	2004		
LEGACY	2005		
OUTBACK	2003		
OUTBACK	2005		

DH5RMH			
For/Per/Für/Pour/Para:			
DAIHATSU			
CUORE	1998	2006	
MOVE	1997	2002	

DWO4RMH			
For/Per/Für/Pour/Para:			
CHEVROLET-DAEWOO			
LACETTI	2004	2009	
NUBIRA SW	2004	2009	

DWO5MH			
For/Per/Für/Pour/Para:			
CHEVROLET-DAEWOO			
CAPTIVA	2006		
EPICA	2006		
EPICA	2008		
EVANDA	2003	2006	
CHEVROLET USA			
CAPTIVA SPORT	2012		
OPEL-VAUXHALL			
ANTARA	2007		

DWO5MH			
SATURN (GM)			
VUE	2008	2010	
FO10MH			
For/Per/Für/Pour/Para:			
FORD SUD-AMERICA			
C-MAX	2004	2007	
ECO-SPORT	2003	2007	
FIESTA	2003	2007	
FIESTA MAX	2005		

FO19MH			
For/Per/Für/Pour/Para:			
LDV			
CONVOY	1998	2000	
CUB	1998	2000	

FO21MH			
For/Per/Für/Pour/Para:			
FORD AUS			
FALCON	1999	2006	
TERRITORY	2004	2005	
FORD EU			
CONNECT	2002		
COUGAR	1997	2002	
COURIER KOMBI	1998		
ESCORT	1995	2000	
FIESTA	1995	2002	
FIESTA	2003	2008	
FOCUS	1998	2004	
FUSION	2002		
KA	1996	2002	
KA	2002	2008	
MONDEO	1995	2001	
MONDEO	2001	2007	
PUMA	1998	2002	
SCORPIO	1995	1998	
TRANSIT	1995	2000	
TRANSIT	2000	2006	
TRANSIT	2007		

FORD SUD-AMERICA			
FOCUS	1998	2007	
KA	2008		
MONDEO	2006	2007	
FORD USA			
TRANSIT CONNECT	2010	2012	
JAGUAR			
S-TYPE	2000	2008	
XJ	2003	2007	
X-TYPE	2002	2008	
MAZDA			
121	1997	2001	

FO26MH			
For/Per/Für/Pour/Para:			
FORD USA			
CONTOUR V6 LX	1998	2000	

FO26MH			
MERCURY			
COUGAR	1999	2002	
MYSTIQUE V6 LS	1997	2002	

FO38RMH			
For/Per/Für/Pour/Para:			
FORD AUS			
ESCAPE	2005		
EXPLORER	1998	2000	
EXPLORER	2001	2003	
EXPLORER	2004		
EXPLORER SPORT TRAC	1998	2001	
EXPLORER SPORT TRAC	2002	2005	
FOCUS	2000	2004	
TAURUS LX / SHO	1998	1999	
TRIBUTE	2001	2003	
FORD SUD-AMERICA			
RANGER	2004		
FORD USA			
CROWN VICTORIA	1998	2002	
CROWN VICTORIA	2003	2012	
EDGE	2007	2009	
EDGE	2007	2010	
E-SERIES VAN	2008	2012	
ESCAPE	2001	2004	
ESCAPE	2005	2012	
EXCURSION	2000	2006	
EXPEDITION	1997	2002	
EXPEDITION	2003	2010	
EXPLORER	1998	2001	
EXPLORER	2001	2003	
EXPLORER	2004	2010	
EXPLORER SPORT TRAC	1999	2001	
EXPLORER SPORT TRAC	2002	2010	
F-150	1998	2004	
F-150	2004	2010	
F-250	1998	2004	
F-250	2004	2010	
F-350	1999	2003	
F-350	2004	2010	
FIVE HUNDRED	2005	2007	
FLEX	2009	2010	
FLEX	2009	2009	
FOCUS	2005	2007	
FREESTAR	2004	2007	
FREESTYLE	2005	2007	
FUSION	2006	2009	
FUSION	2006	2011	
MUSTANG	1998	2004	
MUSTANG	2005	2012	
MUSTANG COBRA	1996	1997	
MUSTANG GT	1996	1997	
RANGER	1999	2000	
RANGER	2001	2010	
RANGER XLT V6	1999	2000	
TAURUS	2000	2003	
TAURUS	2004	2007	
TAURUS	2008	2011	
TAURUS	2008	2009	
TAURUS LX / SHO	1996	1999	
THUNDERBIRD	2002	2005	
WINDSTAR	1999	2000	
WINDSTAR	2001	2003	
HEAVY TRUCKS	2000	2004	

FORD SUD-AMERICA			
RANGER	2004		

FORD USA			
CROWN VICTORIA	1998	2002	
CROWN VICTORIA	2003	2012	
EDGE	2007	2009	
EDGE	2007	2010	
E-SERIES VAN	2008	2012	
ESCAPE	2001	2004	
ESCAPE	2005	2012	
EXCURSION	2000	2006	
EXPEDITION	1997	2002	
EXPEDITION	2003	2010	
EXPLORER	1998	2001	
EXPLORER	2001	2003	
EXPLORER	2004	2010	
EXPLORER SPORT TRAC	1999	2001	
EXPLORER SPORT TRAC	2002	2010	
F-150	1998	2004	
F-150	2004	2010	
F-250	1998	2004	
F-250	2004	2010	
F-350	1999	2003	
F-350	2004	2010	
FIVE HUNDRED	2005	2007	
FLEX	2009	2010	
FLEX	2009	2009	
FOCUS	2005	2007	
FREESTAR	2004	2007	
FREESTYLE	2005	2007	
FUSION	2006	2009	
FUSION	2006	2011	
MUSTANG	1998	2004	
MUSTANG	2005	2012	
MUSTANG COBRA	1996	1997	
MUSTANG GT	1996	1997	
RANGER	1999	2000	
RANGER	2001	2010	
RANGER XLT V6	1999	2000	
TAURUS	2000	2003	
TAURUS	2004	2007	
TAURUS	2008	2011	
TAURUS	2008	2009	
TAURUS LX / SHO	1996	1999	
THUNDERBIRD	2002	2005	
WINDSTAR	1999	2000	
WINDSTAR	2001	2003	
HEAVY TRUCKS	2000	2004	

LINCOLN			
AVIATOR	2003	2007	
BLACKWOOD	2002	2003	
CONTINENTAL	1998	2002	
CONTINENTAL	2002	2004	
LHS	1998		
LS	2000	2006	
LS	2003	2006	
MARK LT	2005	2009	
MKX	2007	2010	
MKZ	2006	2011	
NAVIGATOR	1997	2002	
NAVIGATOR	2002	2008	
TOWN CAR	1998	2002	
TOWN CAR	2003		
ZEPHYR	2006		



# MH-TA Electronic Keys with GTI Transponder

Edition  
FEBRUARY  
2014

FO38RMH		
MONTEGO	2005	2008
MONTEREY	2004	2007
MOUNTAINEER	1998	2001
MOUNTAINEER	2001	2011
SABLE GS	1999	2000
SABLE GS, LS	2000	2007
SABLE LS, SE, SHO	1996	2000

GM45MH		
		
For/Per/Für/Pour/Por/Para:		
CHEVROLET USA	→	→
CAPRICE PPV	2011	2012
HOLDEN	→	→
COMMODORE VE	2006	
PONTIAC	→	→
G8	2008	2009

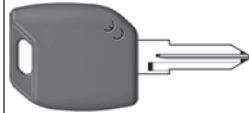
GT10MH		
		
For/Per/Für/Pour/Por/Para:		
IVECO	→	→
35C11	2000	
EUROSTAR	1998	2002
NEW DAILY	1998	
S-2000	1998	

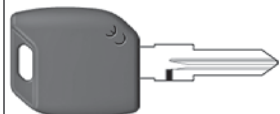
GT15RMH		
		
For/Per/Für/Pour/Por/Para:		
ALFA ROMEO	→	→
SOME MODELS	1995	
FIAT	→	→
SOME MODELS	1995	
LANCIA	→	→
SOME MODELS	1995	
PIAGGIO	→	→
SOME MODELS	1996	

HON58RMH		
		
For/Per/Für/Pour/Por/Para:		
ACURA	→	→
RL	2005	2010
TL	2004	2006
TSX	2004	2007
HONDA	→	→
GOLD WING	2001	

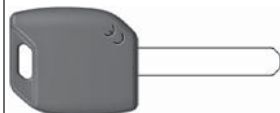
HON66MH		
		
For/Per/Für/Pour/Por/Para:		
ACURA	→	→
CSX	2006	2011
MDX	2007	
RDX	2007	

HON66MH		
ACURA	→	→
TL	2007	
TSX	2007	
ZDX	2010	2012
HONDA	→	→
ACCORD	2003	2006
ACCORD	2008	
CIVIC	2006	
CIVIC (Australia)	2003	
CR-V	2007	
CR-Z	2010	
INSIGHT	2009	
JAZZ	2009	
MDX (Australia)	2003	
STREAM	2008	
HONDA USA	→	→
ACCORD	2003	
ACCORD CrosST	2010	
CIVIC	2006	
CR-V	2007	
CR-Z	2011	
ELEMENT	2006	2011
FIT	2009	
INSIGHT	2010	
ODYSEY	2005	
PILOT	2006	
RIDGELINE	2005	

HON70MH		
		
For/Per/Für/Pour/Por/Para:		
HONDA	→	→
BLACK SPIRIT	2010	
CBF600	2007	2012
CBR600F	1999	2006
CBR600RR	2003	
CBR900	2003	
CBR1000	2004	
CBR1100F	1999	
CBR1100XX	1999	2006
CROSSRUNNER	2011	
CROSSTOURER	2012	
CTX700	2014	
CTX1300	2014	
HORNET	2003	
INTEGRA	2012	
NC700 S	2012	
NC700 X	2012	
NC750 X	2014	
NT650V	1999	2006
NT700V	2006	2012
SHADOW 750	2004	
SILVER WING	2001	2008
ST1300 Pan-European	2008	
SW-T400	2009	
SW-T600	2011	
VARADERO	2003	
VFR800	2006	
VFR1200	2009	
VT750 C4	2004	2010
VT1300CX	2009	
VTX1800C	2002	
X-ELEVEN	2001	2003

HU43MH		
		
For/Per/Für/Pour/Por/Para:		
OPEL-VAUXHALL	→	→
SIGNUM	2003	2005
VECTRA	2002	2005

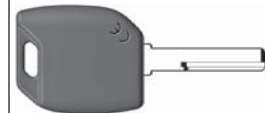
HU56RMH		
		
For/Per/Für/Pour/Por/Para:		
ACURA	→	→
COLT	2004	
SMART	→	→
FORFOUR	2004	2006

HU66MH		
		
For/Per/Für/Pour/Por/Para:		
AUDI	→	→
A8	2004	
PORSCHE	→	→
CAYMAN	2009	

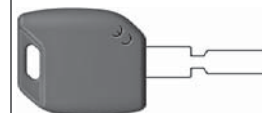
HU71MH		
		
For/Per/Für/Pour/Por/Para:		
SCANIA	→	→
164	2004	
R-SERIES	2005	

HU83MH		
		
For/Per/Für/Pour/Por/Para:		
CITROËN	→	→
C4 PICASSO	2006	
C5	2008	
C8	2002	
DISPATCH	2007	
JUMPY	2007	
FIAT	→	→
SCUDO	2007	
ULYSSE	2002	2011
LANCIA	→	→
PHEDRA	2002	2011
PEUGEOT	→	→
207	2006	
208	2012	
2008	2013	
3008	2009	
307	2001	2009
308	2007	
5008	2009	
807	2002	
EXPERT	2007	
RCZ	2010	

HU87RMH		
		
For/Per/Für/Pour/Por/Para:		
SUBARU	→	→
G3X JUSTY	2004	2007
SUZUKI	→	→
IGNIS	2000	2005

HU92RMH		
		
For/Per/Für/Pour/Por/Para:		
BMW	→	→
SERIE 1	2004	2011
SERIE 3	2005	2011
SERIE 5	2003	2010
SERIE 6	2004	2011
SERIE 7	2002	2008
X5	2004	2011
Z4	2006	2011
LAND ROVER	→	→
RANGE ROVER	2003	2005
RANGE ROVER	2005	2007

HU100MH		
		
For/Per/Für/Pour/Por/Para:		
BUICK	→	→
ALLURE	2010	
LACROSSE	2010	
REGAL	2011	
VERANO	2012	
CADILLAC	→	→
SRX	2010	
CHEVROLET-DAEWOO	→	→
AVEO	2011	
CRUZE	2009	
ORLANDO	2011	
CHEVROLET S.AMERICA	→	→
AGILE	2009	
CHEVROLET USA	→	→
CAMARO	2010	
CRUZE	2011	
EQUINOX	2010	
ORLANDO	2012	
SONIC	2012	
VOLT	2011	
GMC (GM)	→	→
TERRAIN	2010	
HOLDEN	→	→
ASTRA	2004	
VECTRA	2004	
ZAFIRA	2004	
OPEL-VAUXHALL	→	→
AMPERA	2012	
ASTRA	2004	
CORSA	2006	
INSIGNIA	2008	
MERIVA	2010	
MOKKA	2012	
SIGNUM	2003	2008
VECTRA	2004	2008
ZAFIRA	2006	
SATURN (GM)	→	→
ASTRA	2008	2009

HU101MH		
		
For/Per/Für/Pour/Por/Para:		
FORD AUS	→	→
BF FALCON	2005	
TERRITORY	2005	
FORD EU	→	→
FIESTA	2008	2012
FOCUS	2004	2010
FOCUS C-MAX	2003	2010
GALAXY	2006	2010
KUGA	2008	
MONDEO	2007	2010
S-MAX	2006	2010

**IT** IMPORTANTE - In conformità alle disposizioni legali in vigore relative alle proprietà industriali, informiamo che i marchi o le denominazioni commerciali citate nel nostro catalogo sono di proprietà esclusiva dei fabbricanti di serrature e degli utilizzatori autorizzati. Questi marchi o denominazioni commerciali sono indicati a titolo di semplice informazione, con lo scopo di riconoscere velocemente a quali serrature le nostre chiavi sono destinate. Questo catalogo è esclusivamente riservato ai professionisti della riproduzione chiavi che utilizzano i prodotti Silca.  
Le illustrazioni e i dati tecnici dei prodotti contenuti nel catalogo debbono considerarsi indicativi. Silca si riserva il diritto, ferme restando le caratteristiche essenziali dei prodotti, di apportare tutte le modifiche che ritiene necessarie e opportune al fine di migliorare la qualità dei prodotti. Tutti i disegni e le fotografie sono di proprietà di Silca, ogni riproduzione anche parziale, senza autorizzazione scritta della Silca è vietata secondo termini di legge. Per qualsiasi controversia competenti sono gli Uffici Giudiziari dove ha sede l'Azienda, con espressa esclusione di qualsiasi altro foro.





# MH-TA Electronic Keys with GTI Transponder

Edition  
FEBRUARY  
2014

## HU101MH

<b>FORD SUD-AMERICA</b> →		
MONDEO	2007	
<b>LAND ROVER</b> →		
DISCOVERY 3	2006	2009
RANGE ROVER SPORT	2006	2009

## HU133RMH



For/Per/Für/Pour/Por/Para:

<b>FIAT</b> →		
SEDCI	2006	
<b>MARUTI SUZUKI</b> →		
ALTO K10	2010	
A-STAR	2007	
RITZ	2007	
SWIFT	2007	
<b>MARUTI SUZUKI</b> →		
SX4	2007	
WAGON R	2010	
<b>NISSAN</b> →		
PIXO	2009	
<b>OPEL-VAUXHALL</b> →		
AGILA	2008	
<b>SUZUKI</b> →		
ALTO	2009	
GRAND VITARA	2008	
IGNIS	2003	2008
JIMNY	2002	
SPLASH	2008	
SWIFT	2005	
SX4	2006	

## HU134MH



For/Per/Für/Pour/Por/Para:

<b>KIA</b> →		
VENGA	2010	

## HU136MH

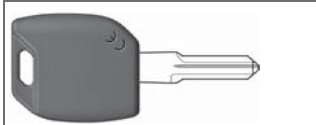

For/Per/Für/Pour/Por/Para:

<b>RENAULT-DACIA</b> →		
DOKKER	2012	
LODGY	2012	
SANDERO	2010	

## HYN6MH

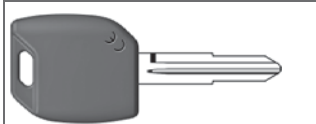

For/Per/Für/Pour/Por/Para:

<b>HYUNDAI</b> →		
ACCENT	1999	2011
COUPE'	1996	2001
COUPE'	2001	2009
ELANTRA	2000	2006
EXCEL	1999	
GALLOPER	1999	2003
GETZ	2002	2009
H-1	1999	2006
H-1	2006	
INNOVATION	1999	2003
LANTRA	1996	2000
LAVITA	2001	2010
MATRIX	2002	2010
SANTA FE	2002	2006
SANTAMO	2000	2003

## HYN6MH

<b>HYUNDAI</b> →		
SCOUPE'	1996	
TERRACAN	2001	2007
TIBURON	2001	2008
TUCSON	2005	2009
VERNA	1999	

## KIA

→		
MORNING	2006	
PICANTO	2004	2008
SPORTAGE	2006	

## HYN7RMH



For/Per/Für/Pour/Por/Para:

<b>HYUNDAI</b> →		
GRANDEUR XG (AUS)	1998	2005
SANTA FE	2000	2002
SONATA	1996	1998
SONATA	1998	2004
SONICA	1996	1998
SONICA	1999	2004
TRAJET	2000	2006
XG25/XG30	1998	2005
XG300 (CANADA)	1998	2005

## KIA

→		
SORENTO	2002	2009

## HYN10MH

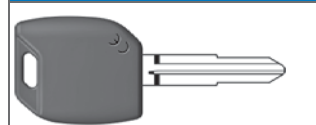

For/Per/Für/Pour/Por/Para:

<b>HYUNDAI</b> →		
ACCENT	1996	1999
ATOS	1997	2000
ATOS PRIME	1999	2001
ATOS PRIME	2002	2008
EXCEL	1996	1999
PONY	1995	1999
VERNA	1996	1999

## HYN12MH

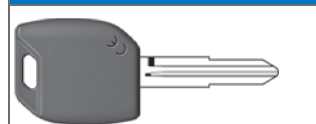

For/Per/Für/Pour/Por/Para:

<b>HYUNDAI</b> →		
STAREX	1998	2006

## HYN14MH



For/Per/Für/Pour/Por/Para:

<b>HYUNDAI</b> →		
ENTOURAGE	2007	2009
H-1 BUS	2007	
I10	2008	

## KIA

→		
CARENS	2006	
CARNIVAL	2006	
OPTIMA	2006	
SEDONA	2006	

## HYN14RMH



For/Per/Für/Pour/Por/Para:

<b>HYUNDAI</b> →		
ELANTRA	2007	
GENESIS C.PE	2010	
iLOAD	2008	
iMAX	2008	
SANTA FE	2006	
SONATA	2005	
VERACRUZ	2007	

## KIA

→		
FORTE (CDN)	2008	2011
MAGENTIS	2006	2008
RONDO	2007	2010
SOUL	2009	

## HYN15MH



For/Per/Für/Pour/Por/Para:

<b>KIA</b> →		
RIO	2006	2009

## ISU5MH



For/Per/Für/Pour/Por/Para:

<b>ISUZU</b> →		
ELF	2009	
F-SERIES	2009	
N-SERIES	2009	

## KIA3RMH



For/Per/Für/Pour/Por/Para:

<b>KIA</b> →		
CARENS	2001	2006
CARNIVAL	2002	2005
JOICE	2000	2003
MAGENTIS	2001	2006
MENTOR	2002	2004
OPTIMA	2001	2006
RIO	2001	2005
RONDO	2001	2006
SEDONA	2002	2005
SEPHIA	2002	2004
SPORTAGE	2001	2003

## KW14MH



For/Per/Für/Pour/Por/Para:

<b>KAWASAKI</b> →		
NINJA 650	2012	
NINJA 1000	2011	
NINJA ZX-10R	2011	
NINJA ZX-14R	2012	
Z1000	2011	
ZZR1400	2012	

## KW16MH



For/Per/Für/Pour/Por/Para:

<b>KAWASAKI</b> →		
NINJA ZX-6R	2006	
NINJA ZX-10R	2004	2010
NINJA ZX-12R	2002	2006
NINJA ZX-14	2006	2011
Z1000	2004	2009
Z750S	2006	
ZZR 1200	2002	2006
ZZR 1400	2007	2011

## MAZ24RMH



For/Per/Für/Pour/Por/Para:

<b>MAZDA</b> →		
CX-7	2007	
CX-9	2007	
DEMIO (J)	2003	
MAZDA 2	2003	
MAZDA 3	2004	
MAZDA 5	2005	
MAZDA 6	2003	
MX-5	2005	
RX-8	2004	

## MIT8MH



For/Per/Für/Pour/Por/Para:

<b>MITSUBISHI</b> →		
CHALLENGER	1999	2002
CHALLENGER	2002	2003
DIAMANTE	2002	2006
ECLIPSE	1996	2000
ECLIPSE	2001	2005
EXPRESS	1996	
FOCUS	1998	
GALANT	1996	2000
GALANT	2002	2005
L200	2002	2006
L200	2006	
MONTERO	1996	2000
MONTERO	2001	2006
MONTERO	2002	2003
MONTERO	2002	2005
MONTERO SPORT	2000	2002
MONTERO SPORT	2001	2004
MONTERO SPORT	2002	2005
NIMBUS	1998	1999
OUTLANDER	2000	2003
PAJERO	1996	2000
PAJERO	2000	2002
PAJERO	2002	2003
PAJERO	2002	2005
PAJERO	2006	
PAJERO SPORT	1999	2002
PAJERO SPORT	2002	2003
PAJERO SPORT	2002	2006
SHOGUN	1996	2000
SHOGUN	2000	2002
SHOGUN	2002	2003
SHOGUN	2002	2005
SHOGUN SPORT	1999	2002
SHOGUN SPORT	2002	2003
SPACE GEAR	1996	
SPACE RUNNER	1998	1999
SPACE WAGON	1998	1999
SPACE WAGON	1999	
VERADA	2002	2003

DE WICHTIG - Gemäß den derzeit geltenden Normen bezüglich des Industrieigentums teilen wir Ihnen mit, daß die im vorliegenden Katalog angeführten Markennamen oder Handelsmarken ausschließliches Eigentum der Schloßhersteller und zugelassenen Fachhändler sind. Diese Markenbezeichnungen oder Handelsmarken sind nur zur Information angeführt, mit dem Zweck, schnell erkennen zu können, zu welchem Schloß unsere Schlüssel gehören. Der vorliegende Katalog ist ausschließlich an Schlüsselkopier-Fachgeschäfte, die Silca Produkte benutzen, gerichtet. Die Abbildungen und technischen Daten des Katalogs sind nur zur Information. Silca behält sich vor, etwaige Änderungen am Produkt, die zur Verbesserung desselben beitragen vorzunehmen. Alle Zeichnungen und Fotos sind Besitz der Firma Silca, jede Reproduktion, auch teilweise, ist ohne schriftliche Erlaubnis der Firma Silca gesetzlich untersagt. Im Falle von Streitfragen ist der Gerichtshof des Firmensitzes zuständig; jeder andere Gerichtshof ist ausgeschlossen.



# MH-TA Electronic Keys with GTI Transponder

Edition  
**FEBRUARY**  
2014

## MIT11RMH



For/Per/Für/Pour/Por/Para:

CITROËN	→	→
C-CROSSER	2007	
C-ZERO	2011	

## MITSUBISHI

	→	→
80	2006	
COLT	1996	2000
ECLIPSE	2008	2012
ENDEAVOR	2007	2011
GALANT	2006	
GALANT (USA)	2008	2012
GRANDIS	2003	
I-MIEV	2010	
LANCER	1996	2003
LANCER	2003	2006
LANCER	2006	
LANCER SW	1996	2006
MIRAGE	1996	2002
MONTERO IO	2000	2006

## MITSUBISHI

	→	→
OUTLANDER	2004	2006
OUTLANDER	2006	
PAJERO IO	1999	
PAJERO MINI [J]	1999	
PAJERO PININ	1999	
SHOGUN PININ	1999	

## PEUGEOT

	→	→
4007	2007	
ION	2011	

## NE72MH



For/Per/Für/Pour/Por/Para:

NISSAN	→	→
INTERSTAR	2002	2010
PRIMASTAR	2003	

## OPEL-VAUXHALL

	→	→
MOVANO	2002	2010
VIVARO	2002	

## RENAULT

	→	→
CLIO II	2001	2012
MASTER	2002	2010
THALIA	2001	2008
TRAFIC	2002	

## RENAULT-DACIA

	→	→
SYMBOL	2010	

## NE73MH



For/Per/Für/Pour/Por/Para:

NISSAN	→	→
INTERSTAR	2002	2010

## OPEL-VAUXHALL

	→	→
MOVANO	2002	2010

## PEUGEOT

	→	→
106	2000	2004
206	2001	2009
206 Cabrio	2002	2007
206 PLUS	2009	

## RENAULT

	→	→
AVANTIME	2001	2003
MASTER	2002	2010
MEGANE	1998	2000
MEGANE	2000	2003

## NE75MH



For/Per/Für/Pour/Por/Para:

LAND ROVER	→	→
FREELANDER	2003	2006

## NE78MH

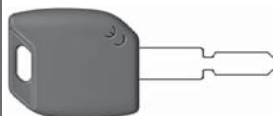

For/Per/Für/Pour/Por/Para:

PEUGEOT	→	→
406	2002	2004
607	2004	2010

## NSN11MH

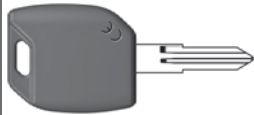

For/Per/Für/Pour/Por/Para:

NISSAN	→	→
ATLEON	2002	
CAB STAR	2000	2003
CAB STAR	2003	2007
MICRA	2000	2003
MICRA MARCH [J]	2000	2003
MICRA VAN	2000	
TERRANO II	2002	2006
VANETTE	2000	
VANETTE CARGO	2000	

## NSN14MH



For/Per/Für/Pour/Por/Para:

INFINITI	→	→
FX35	2003	2009
FX45	2003	2009
G20	2000	2002
G35	2003	2007
I30	2001	2004
I35	2001	2004
M35	2003	2004
M45	2003	2006
Q45	1997	2000
Q45	2001	2005
QX4	1997	1999
QX4	1999	2003
QX56	2004	2007

## NISSAN

	→	→
ALMERA	2000	2003
ALMERA	2003	2006
ALMERA TINO	2000	2003
ALMERA TINO	2004	2006
JUKE	2010	
MICRA	2003	
MURANO	2003	2007
NAVARA	2003	2005
NAVARA	2005	
NOTE	2006	
NP300	2010	
PATHFINDER	2005	
PATROL	2004	
PRIMERA	1998	2000
PRIMERA	2002	
PULSAR	1998	2000
QASHQAI	2007	
XTERRA	2000	2004
X-TRAIL	2001	2003
X-TRAIL	2004	

## NSN14MH

### NISSAN USA

	→	→
350Z	2003	2009
ALTIMA	2005	2006
ARMADA	2004	
CUBE	2009	
FRONTIER	2002	2005
FRONTIER	2005	
JUKE	2011	
LIVINA	2007	
MAXIMA	2000	2003
MAXIMA	2004	2007
MURANO	2003	2008
NV Series	2012	
PATHFINDER	2005	
QUEST	2004	2010
ROGUE	2007	
SENTRA	2007	
TIIDA	2007	
TITAN	2004	
VERSA	2007	
XTERRA	2005	2012
X-TRAIL	2005	2006

## SUBARU

	→	→
FORESTER	1998	2003
IMPREZA	1998	2003
LEGACY	1998	2003
OUTBACK	1998	2003

## SUZUKI

	→	→
EQUATOR	2009	

## NSN19MH



For/Per/Für/Pour/Por/Para:

NISSAN	→	→
CAB STAR	2007	

## RENAULT

	→	→
MAXITY	2007	

## SUBARU

	→	→
B9 TRIBECA	2006	2011
BAJA	2005	2007
FORESTER	2004	2007
FORESTER (AUS)	1998	2004
IMPREZA	2004	2007
IMPREZA (AUS)	1998	2004
LIBERTY (AUS)	1998	2003
OUTBACK (AUS)	1998	2003

## PO1RMH



For/Per/Für/Pour/Por/Para:

PROTON	→	→
415	1996	1998
416	1996	1998

## SIP16MH



For/Per/Für/Pour/Por/Para:

ALFA ROMEO	→	→
166	2000	2004

## SIP22MH

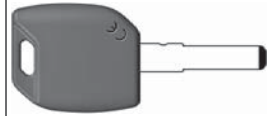

For/Per/Für/Pour/Por/Para:

ABARTH	→	→
500	2008	
GRANDE PUNTO	2007	2010
PUNTO	2012	
PUNTO EVO	2010	2012

## ALFA ROMEO

	→	→
156	2001	2003
156 SPORT WAGON	2001	2007
166	2004	2008
GIULIETTA	2010	
MiTo	2008	

## CITROËN

	→	→
NEMO	2008	
RELAY	2006	

## FIAT

	→	→
500	2007	
500L	2012	
BRAVO	2007	
DOBLO'	2006	
DUCATO	2006	
FIORINO	2007	
GRANDE PUNTO	2005	
IDEA	2009	
PANDA	2002	
PUNTO	2012	
PUNTO EVO	2009	2012
QUBO	2008	

## FORD EU

	→	→
KA	2009	

## IVECO

	→	→
EUROCARGO	2002	2007
STRALIS	2002	2007

## LANCIA

	→	→
DELTA	2008	
MUSA	2009	
YPSILON	2011	

## PEUGEOT

	→	→
BIPPER	2009	

## SIP36MH



For/Per/Für/Pour/Por/Para:

ALFA ROMEO	→	→
GIULIETTA	2010	

## CITROËN

	→	→
JUMPER	2006	

## FIAT

	→	→
DUCATO	2006	

## PEUGEOT

	→	→
BOXER	2006	

## SSY3MH



For/Per/Für/Pour/Por/Para:

SSANGYONG	→	→
ACTYON	2007	
KYRON	2005	
REXTON	2006	

**FR** IMPORTANT - Conformément aux lois en vigueur concernant la propriété industrielle, nous vous informons que les marques et appellations commerciales citées dans notre catalogue appartiennent exclusivement aux fabricants de serrures et aux utilisateurs autorisés. Ces marques ou appellations commerciales sont indiquées à titre d'information pure et simple pour vous permettre de déterminer rapidement les serrures auxquelles nos clés sont destinées. Ce catalogue est réservé exclusivement aux professionnels du taillage de clés qui utilisent les produits Silca.

Les illustrations et les caractéristiques techniques des produits présentés dans ce catalogue sont données à titre indicatif. Bien que les caractéristiques essentielles des produits soient invariables, Silca se réserve le droit d'apporter toutes les modifications qu'elle retiendra nécessaires et opportunes afin d'améliorer la qualité de ses produits. Tous les dessins et photos sont propriété Silca et toute reproduction, même partielle, sans l'autorisation écrite préalable de Silca est interdite conformément aux prescriptions légales. Tout litige est du ressort exclusif des Tribunaux de la circonscription où se trouve le Siège de la Société.



# MH-TA Electronic Keys with GTI Transponder

Edition  
FEBRUARY  
2014

## SX9MH

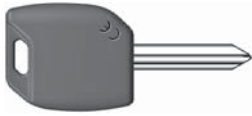

For/Per/Für/Pour/Por/Para:

CITROËN	→	→
BERLINGO	2001	2002
C5	2000	2004
DISPATCH	2002	2006
JUMPY	2002	2006
SAXO	2000	2003
XSARA	2001	2006
XSARA PICASSO	2000	2006
FIAT	→	→
SCUDO	2002	2006
PEUGEOT	→	→
EXPERT	2002	2006
PARTNER	2001	2002
RANCH	2001	2002

## SZ11MH



For/Per/Für/Pour/Por/Para:

MARUTI SUZUKI	→	→
ALTO	2007	2010
SUZUKI	→	→
ALTO	2002	2008

## SZ11RMH



For/Per/Für/Pour/Por/Para:

MARUTI SUZUKI	→	→
VERSA	2007	2010
WAGON R	2007	2010
ZEN ESTILO	2007	2010
SUZUKI	→	→
ALTO	1996	2002
ALTO	2002	2008
BALENO	1996	2001
ESCUDO [J]	1996	2002
GRAND VITARA	1996	2002
GRAND VITARA	2002	2008
IGNIS	2000	2008
JIMNY	1999	2002
JIMNY	2002	
SWIFT	1996	2005
VITARA	1996	2002
VITARA	2002	2008
WAGON R.	1998	2000

## SZ12MH



For/Per/Für/Pour/Por/Para:

ISUZU	→	→
BIG HORN	1998	2002
TROOPER	1998	2002
SUBARU	→	→
JUSTY	1996	2003
SUZUKI	→	→
ALTO	1996	2002
BALENO	1996	2001
ESCUDO [J]	1996	2002
GRAND VITARA	1996	2002
SWIFT	1996	2005
VITARA	1996	2002

## SZ17RMH

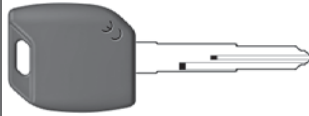

For/Per/Für/Pour/Por/Para:

SUZUKI	→	→
GSF BANDIT	2007	
GSF600	2007	
GSX1300 HAYABUSA	2007	
GSX-R1000	2006	
GSX-R600	2006	
GSX-R750	2006	
V-STROM	2007	

## SZ18MH



For/Per/Für/Pour/Por/Para:

MARUTI SUZUKI	→	→
800	2007	2010

## SZ18RMH

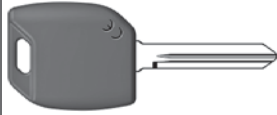

For/Per/Für/Pour/Por/Para:

MARUTI SUZUKI	→	→
ESTEEM	2007	
OMNI	2007	2010

## SZ22MH

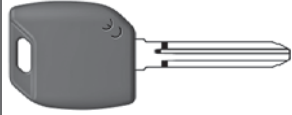

For/Per/Für/Pour/Por/Para:

SUZUKI	→	→
GRAND VITARA	2006	2008
LIANA	2001	2005
LIANA	2006	2007
SWIFT	2005	

## TAT1MH

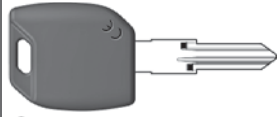

For/Per/Für/Pour/Por/Para:

TATA	→	→
ARIA	2010	
INDICA	2000	
INDIGO	2008	
MANZA	2009	2010

## TOY40MH



For/Per/Für/Pour/Por/Para:

HYUNDAI	→	→
AZERA	2005	2010
ELANTRA NEOS	2007	
GENESIS	2009	
GRANDEUR	2006	
I20	2008	
I30	2007	2011

## TOY40MH

KIA	→	→
AMANTI	2004	2006
AMANTI	2007	2010
CEE'D	2007	2011
CEE'D SW	2007	2011
OPIRUS	2003	2006
PICANTO	2008	2011
RONDO	2011	
SORENTO	2010	

## LEXUS

LEXUS	→	→
CELSIOR [J]	1997	
ES300	1998	2001
LAND CRUISER	1999	
LS400	1997	
LX450	1998	
LX470	1999	2000
SC300/400	1998	2003

## mitsubishi

MITSUBISHI	→	→
MAGNA	1999	2005
VERADA (AUS)	2000	2002

## TOYOTA

TOYOTA	→	→
CENTURY	1998	
LAND CRUISER 100	1998	2000

## TOYOTA JAPAN

TOYOTA JAPAN	→	→
CELSIOR	1998	2004

## TOY41RMH



For/Per/Für/Pour/Por/Para:

DAIHATSU	→	→
CHARADE	1998	2004
COPEN	2002	
CUORE	1998	2006
CUORE	2007	
FEROZA	1995	1998
MATERIA	2006	
SIRION	1998	2004
SIRION	2005	
TERIOS	1997	2005
TERIOS	2006	
TREVIS	2007	
YRV	2000	2005

## TOYOTA

TOYOTA	→	→
ECHO	1999	2005
MR2	1997	2007
YARIS	1999	2005

## TOYOTA JAPAN

TOYOTA JAPAN	→	→
PLATZ	1999	2002

## TOYOTA USA

TOYOTA USA	→	→
MR2	2001	2005

## TOY43MH



For/Per/Für/Pour/Por/Para:

PONTIAC	→	→
VIBE	2009	2010
SCION	→	→
TC	2005	2010
XA	2004	2007
XB	2004	2008
XD	2008	2012

## SUZUKI

SUZUKI	→	→
LIANA	2001	2005
LIANA	2006	2007
SWIFT	2005	

## TOY43MH

TOYOTA	→	→
4RUNNER	1999	2002
ALPHARD	2005	
AURION (Aus)	2006	
AURIS	2006	
AVENSIS VERSO	2001	2003
CAMRY	1996	2005
CAMRY	2006	
CELICA	2000	2005
COROLLA	1996	2006
COROLLA	2007	
ECHO VERSO	2002	2005
FJ CRUISER	2007	
FORTUNER	2007	
HIACE	1995	2006
HIACE	2007	
HILUX	1999	2004
HILUX	2005	
INNOVA KIJANG	2005	
iQ	2008	
LAND CRUISER 100	1998	2002
LAND CRUISER 100	2003	2008
LAND CRUISER 120	2002	
LAND CRUISER 90	1996	2002
LAND CRUISER PRADO	2002	
PICNIC	1996	2003
PICNIC	2003	2008
PREVIA	2000	2003
PREVIA	2003	2008
PRIUS	2000	2003
RAV 4	1996	2004
RAV 4	2005	
REIZ	2005	
REIZ	2005	
T.U.V.	2003	
TARAGO	2003	2008
VIOS	2007	
WISH	2004	

## TOYOTA JAPAN

TOYOTA JAPAN	→	→
ALPHARD	2003	
bb	2000	2005
CALDINA	2002	2004
COROLLA FIELDER	2004	
COROLLA RUNX	2004	
COROLLA SPACIO	2003	
DYNA	2008	
ESTIMA	2001	2003
ESTIMA	2003	
FUN CARGO	2003	2005
GAIA	1999	2004
IPSUM	1996	2003
IPSUM	2003	
ISIS	2003	
IST	2003	
KLUGER	2001	2003
KLUGER	2003	
LAND CRUISER PRADO	2000	2002
LAND CRUISER PRADO	2002	2005
MARK 2	2000	2006
MARK X	2004	
NOAH	2004	
OPEN DECK	2000	2005
PLATZ	2003	2005
PRONARD	2000	2002
RAUM	2003	
RAV 4	2003	
REGIUSACE	2007	
SIENTA	2003	
TOYOACE	2008	
VANGUARD	2005	
VEROSSA	2001	2004
VITZ	2003	
VOXY	2004	
WISH	2003	

## TOYOTA USA

TOYOTA USA	→	→
4RUNNER	1999	2002
4RUNNER	2003	2010
AVALON	1998	2004
AVALON	2005	2011
AVANZA	2004	
CAMRY	1998	2004
CAMRY	2003	2010
COROLLA	2005	2010
FJ CRUISER	2007	2010
HIACE	2006	
HIGHLANDER	2001	2003
HIGHLANDER	2004	2010
LAND CRUISER	1998	2002
LAND CRUISER	2003	2008
MATRIX	2005	2010
PRIUS	2001	2003
PRIUS	2004	2008
RAV 4	2006	2010
SEQUOIA	2001	2002
SEQUOIA	2003	2010
SIENNA	1999	2003
SIENNA	2004	2010
SOLARA	2002	2003
SOLARA	2004	2010
TACOMA	2005	2010
TUNDRA	2005	2010
VENZA	2009	2010
YARIS	2007	2011

**ES IMPORTANTE** - En conformidad con las disposiciones legales vigentes sobre la Propiedad Industrial, las marcas y denominaciones comerciales citadas en nuestra documentación se declaran propiedad exclusiva de los fabricantes de cerraduras y los usuarios autorizados. Dichas marcas o denominaciones comerciales se citan con mero carácter informativo, con objeto de hacer comprender sin dificultad a qué cerraduras van destinadas nuestras llaves. Esta documentación está reservada exclusivamente a los profesionales de la duplicación de llaves que utilizan los productos Silca.

Las ilustraciones y los datos técnicos de los productos en esta documentación son indicativos. Silca se reserva el derecho, quedando invariables las características principales de los productos, de modificar todo lo que considere necesario y oportuno para mejorar la calidad de sus artículos. Todos los dibujos y fotografías pertenecen a Silca; según determina la Ley, se prohíbe toda reproducción, total o parcial, sin autorización por escrito de Silca S.p.A. En caso de disconformidad, la competencia es de las autoridades judiciales donde esté domiciliada la firma, excluyendo cualquier otro Tribunal.



# MH-TA Electronic Keys with GTI Transponder

Edition  
FEBRUARY  
2014

## TOY43RMH

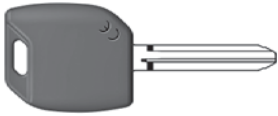

For/Per/Für/Pour/Para:

<b>HOLDEN</b>	→	→
COLORADO	2008	
<b>ISUZU</b>	→	→
D-MAX	2007	

## TOY46RMH



For/Per/Für/Pour/Para:

<b>TOYOTA</b>	→	→
COROLLA	1996	1999

## TOY47MH

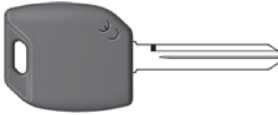

For/Per/Für/Pour/Para:

<b>DAIHATSU</b>	→	→
CHARADE	2011	
<b>TOYOTA</b>	→	→
AURIS (EU)	2007	
AVENSIS	1998	2000
AVENSIS	2000	2003
AVENSIS	2003	
CARINA	1996	2000
COROLLA	1999	2006
COROLLA (S.Africa)	2008	
YARIS	1999	2005
YARIS	2005	2011

## TOY48MH



For/Per/Für/Pour/Para:

<b>LEXUS</b>	→	→
ALTEZZA [J]	1999	
ES300	2002	2003
ES330	2004	2007
GS/LS/LX	1998	
GS300	1998	2005
GS300	2005	2007
GS300/400 [J]	1998	
GS400	1998	2001
GS430	2001	2005
GS430	2005	2007
GS470	2003	2007
IS200	1999	2005
IS300	2001	2005
LS200	1999	
LS400	1999	2003
LS430	2001	2006
LX470	2001	2002
LS470	2003	2008
RX300	1999	2003
RX330	2004	2009
RX350	2004	2011
RX400h	2005	2009
RX450h	2010	
SC430	2002	2010

## TOY48MH

<b>TOYOTA</b>	→	→
LAND CRUISER 100	2000	2002
LAND CRUISER 100 (AUS)	2003	
<b>TOYOTA JAPAN</b>	→	→
ARISTO	1998	2005
BREVIS	2001	2007
CELSIOR	1998	2004
CROWN	1999	2005
LAND CRUISER PRADO	2000	2002
ORIGIN	2000	
PROGRES NC300	1998	2006
WINDOM	2001	2004

## TOY49MH

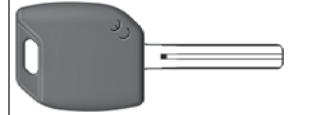

For/Per/Für/Pour/Para:

<b>HYUNDAI</b>	→	→
I20	2008	
I30	2007	2011
I40 (AUS)	2010	
I45	2009	
IX20	2010	
IX35	2010	
<b>KIA</b>	→	→
BORREGO	2009	2011
MAGENTIS	2009	2011
OPIRUS	2007	2010
RIO	2010	2011

## VA2MH

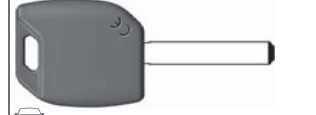

For/Per/Für/Pour/Para:

<b>SMART</b>	→	→
FORTWO	2009	

## VA6MH

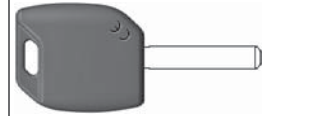

For/Per/Für/Pour/Para:

<b>CITROËN</b>	→	→
BERLINGO	2002	
C1	2004	
C2	2003	
C3	2002	
C3 PICASSO	2008	
C4	2005	
C5	2006	2008
C6	2006	
DS3	2010	
DS4	2011	
<b>NISSAN</b>	→	→
NV400	2011	
<b>OPEL-VAUXHALL</b>	→	→
MOVANO	2011	
<b>PEUGEOT</b>	→	→
107	2005	
407	2004	2011
508	2011	
1007	2004	
PARTNER	2002	
RANCH	2002	2007

## VA6MH

<b>RENAULT</b>	→	→
CLIO III	2006	
KANGOO	2011	
MASTER	2011	
MODUS	2004	
TWINGO	2007	
<b>TOYOTA</b>	→	→
AYGO	2005	

## VAC102MH

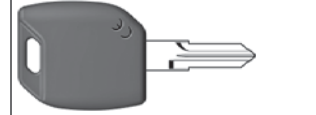

For/Per/Für/Pour/Para:

<b>RENAULT</b>	→	→
KANGOO	2002	2010
TWINGO	2002	2007
<b>RENAULT-DACIA</b>	→	→
DUSTER	2010	
LOGAN	2006	
SANDERO	2008	

## YH35RMH



For/Per/Für/Pour/Para:

<b>YAMAHA</b>	→	→
BT1100 BullDog	2005	
FJR1300	2005	
FZ1	2006	
FZ6	2004	2011
FZ8	2010	
FZS1000 FAZER	2005	
Majesty 400	2005	
MT-01	2005	2012
MT-03	2006	
TDM600	2005	
T-MAX 500	2005	2012
XJR 1300	2004	
XT1200Z Super Ténéré	2010	
XT660Z Ténéré	2008	
XTR	2004	
XTX	2004	
XVS650A DragStar	2004	2006
XVS1100A DragStar	2004	
YZF-R1	2005	
YZF-R6	2003	

## ZD24RMH

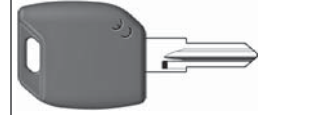

For/Per/Für/Pour/Para:

<b>HONDA</b>	→	→
SH300	2007	
<b>TRIUMPH</b>	→	→
TIGER	2010	
<b>YAMAHA</b>	→	→
X-MAX 125	2006	

ATTENTION / ATTENZIONE / ACHTUNG /  
ATTENTION / ATENCION / ATENÇÃO



**IMPORTANT / IMPORTANTE  
WICHTIG / IMPORTANT  
IMPORTANTE / IMPORTANTE**

All information and illustrations in this list are for guidance only. / Le illustrazioni e i dati tecnici dei prodotti contenuti nella lista presente debbono considerarsi indicativi. / Die Abbildungen und technischen Daten in dieser List sind nur zur Information. / Les illustrations et les caractéristiques techniques des produits présentés dans cette liste sont données à titre indicatif. / Las ilustraciones y los datos técnicos de los productos en esta lista son indicativos. / As ilustrações e as características técnicas dos produtos apresentados nesta lista são facultados a título indicativo.

→ In production from year... / Fabricata dall'anno... / Hergestellt seit Jahr... / Fabriqué à partir de l'année... / Fabricada desde el año... / Em produção do ano...

→ In production until year... / Fabricata fino all'anno... / Hergestellt bis Jahr... / Fabriqué jusqu'à l'année... / Fabricada hasta el año... / Em produção até ano...

**PT IMPORTANTE** - Em conformidade com as disposições legais em vigor relativas à propriedade industrial, informamos que as marcas ou as denominações comerciais citadas no nosso catálogo são propriedade exclusiva dos fabricantes de fechaduras e dos utilizadores autorizados. Estas marcas ou denominações comerciais são indicadas só a nível de informação, a fim de reconhecer rapidamente a quais fechaduras se destinam as nossas chaves. Este catálogo é reservado exclusivamente aos profissionais da reprodução de chaves que utilizam os produtos Silca.

As ilustrações e as características técnicas dos produtos apresentados neste catálogo são facultados a título indicativo. Mesmo que as características essenciais dos produtos sejam invariáveis, a Silca reserva-se o direito de modificar ser necessário e oportuno los productos, a fim de melhorar a sua qualidade. Todos os desenhos e fotos são propriedade da Silca, e é proibida a sua reprodução mesmo parcial sem a autorização escrita da Silca conforme as prescrições legais. Em caso de litígio fica desde já designado, excluindo qualquer outro, o Tribunal da comarca onde está registada a sede da Silca.